

Designing a Self-Stabilizing Robot For Dynamic Mobile Manipulation

Patrick Deegan Bryan J. Thibodeau Roderic Grupen

Laboratory for Perceptual Robotics

Department of Computer Science

University of Massachusetts Amherst

Amherst, MA 01003

Email: {pdeegan, thibodea, grupen}@cs.umass.edu

Abstract— The UMASS uBot-4 is a two wheeled, dynamically stable, bimanual mobile manipulator. It is a compact, safe, and cost effective platform with many features such as whole body postural control, force sensing actuators, two 4-DOF arms, and a small footprint. It is the latest in a series of small mobile robots that originated with the uBot-0.5 (ca. 1997). This paper presents the motivations for the design of the uBot series and describes how the platform evolved from a small reactive heat-seeking robot to a highly capable mobile manipulator.

I. INTRODUCTION

In this paper, we present the incremental design of a new mobile manipulator, the UMASS uBot. The uBot-4 is a dynamically balancing, two-wheeled platform with a rotating trunk and two four degree of freedom arms. The arm actuators feature intrinsic force sensing and compliance. This system embodies a set of features designed to function in open, unstructured, and human centric environments. Similar to many humanoid robots, the uBot-4 can exploit the inertial dynamics and gravitational potential of its entire body to preserve postural stability and generate forces on external objects[1]. In addition to being safe, robust, cost effective, and agile, the uBot-4 is designed to be able to right itself in the event that it falls over.

For operation in human centric environments, we feel that a mobile manipulator should have a morphology similar to that of a human. Key aspects of this morphology are sensors at a sufficient height to oversee a bimanual workspace and a small footprint and narrow aspect ratio. The most natural way to achieve these goals is to build upon a base characterized by dynamic stability, either using wheels or legs.

Without legs, the uBot-4 is nearly a third of the height of an average human. Even at this scale, it can still perform tasks that are relevant to human-centric environments. Besides the lifting and pushing tasks we have performed with uBot-4, we plan to conduct experiments that will demonstrate pulling, digging, and throwing. In addition, the platform is designed to accommodate a variety of end effectors as well as perform cooperative manipulation tasks requiring multiple uBots. This form factor was also chosen to provide safety to humans and the robot's environment as well as achieve a low price point.

Research into manual dexterity and mobile manipulation is timely and important[2]. The uBot-4 was designed in part to

be a robot capable of addressing current challenges in mobile manipulation. We will further motivate the design of the new platform by providing a brief history of the four predecessor designs that culminated in the uBot-4. Finally, the system's early capabilities are demonstrated in a simple drawer pushing experiment.

II. RELATED WORK

A. Manipulation in Human Environments

There are a large number of humanoid robots currently used in the research community. The Honda ASIMO [3] and the HRP-2 [4] are two examples of humanoid robots suitable for mobile manipulation tasks. Both the uBot-4 and humanoid robots have form factors suitable for bi-manual mobile manipulation in human centric environments and both have the ability to perform whole body postural control. The main difficulty is that the cost and availability of humanoid robots put them out of the reach of many researchers. Much of the cost and complexity of humanoid robots is due to the use of legs. A robot that balances on two wheels can still perform whole body postural control and retains a form factor similar to that of a humanoid, but can be much simpler and less expensive. Although a legged robot could possibly traverse a greater variety of terrains than a wheeled robot, many terrains that are accessible for humans are also accessible to a wheeled robot, providing a suitably rich environment in which to perform manipulation tasks.

B. Two Wheeled Balancing Robots

There are many robots without manipulation capabilities that balance around two wheels such as the Segway[®] Robotic Mobility Platform (RMP) [5], nBot [6], and JOE [7]. There also exist holonomic robots, such as Ballbot, which balance around a single spherical wheel [8]. Cardea consists of a robotic arm on a Segway RMP and has successfully demonstrated a door finding, approaching, and opening task [9]. The most ambitious dynamic balancer is perhaps the configuration of the JSC Robonaut mounted on a Segway RMP [10]. Though these robots have demonstrated impressive manipulation capacity, they have a number of drawbacks. Such robots can be very heavy. The Segway RMP without a manipulator attached can weigh 57Kg or more[11], and the

manipulator itself can add much more mass. This can present a serious danger to both the robot's environment and the robot itself as the robot would generate very large impact forces if it were to fall over. Since the robot is not likely to survive a fall it must not attempt any destabilizing tasks. Platforms such as these may rely on special purpose hardware to prevent falls or damage, but typically this hardware is only for emergency, and not for routine use[5].

III. uBOT SERIES

The uBot-0.5 (Figure 1) was constructed in 1997. The design goal was to produce a small robot that would use a reactive control framework to autonomously search for hot objects. To meet these requirements, a platform was constructed from inexpensive and widely available materials and hardware. Hobby airplane wheels were attached to a base made from PCB perf board in a differential drive configuration. Hobby airplane casters were placed at the front and back for static stability.

A sonar transducer and a pyroelectric detector were mounted on a mast whose orientation was controlled by an unmodified hobby servo motor. The mast was used to continuously scan the environment for obstacles and thermal signatures in a range of approximately 60 degrees to each side of the front of the robot. The reactive control framework was capable of turning the robot away from obstacles in its path and drive towards objects detected by the pyroelectric sensor. Since no environmental models were generated and the reactive control scheme was deterministic, the robot could become caught in tightly looped and/or suboptimal action sequences[12].



Fig. 1. The first in the series, uBot-0.5.

uBot-1 borrowed design ideas from the uBot-0.5 including a small form factor and limited computation power. The uBot-1 (Figure 2) improved upon the design by incorporating high performance motors, reconfigurable sensors (infrared proximity), and wireless communication (infrared or radio). This

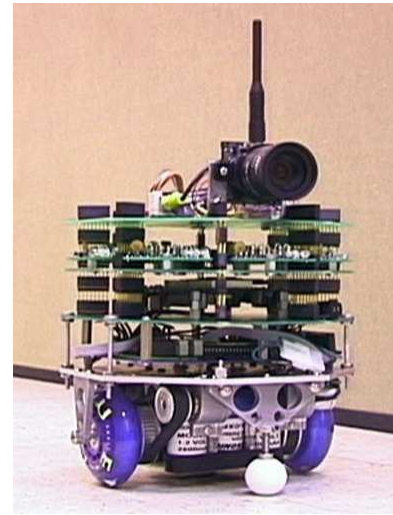

Fig. 2. uBot-1 navigating a maze-like environment.

configuration was used for exploring maze-like environments and multiple robot collaboration.

The uBot-1 was used to study multi-objective, concurrent control schema in the domain of swarm behavior. The uBot-1 demonstrated a control theoretic framework for managing control interactions across multiple platforms. This approach, a generalization of null-space control, was able to preserve global properties while allowing exploration within "safe" control options. Sweeney et al. [13] demonstrate this framework in a maze exploration task where pairs of robots maintained line-of-sight constraints while protecting global network connectivity. Figure 3 shows two uBot-1 robots searching a maze using a leader-follower control composition while simultaneously preserving visual line of sight. uBot-1 had a modular design so that the user could rapidly reconfigure its sensor package. The control scheme also supported control collaboration over heterogeneous teams.

One of the disadvantages of its design was that the drive system performed poorly on surfaces that were not smooth and flat. This was because its inline skate wheels provided limited surface contact and thus limited traction. To compound the problem, the spherical Teflon[®] casters, that provided static stabilization, had small contact areas with the floor and tended to catch and stick in small surface imperfections.

By removing the casters altogether and making the uBot platform a dynamic balancer, this limitation could be overcome. Reconfigured this way, uBot-2 (Figure 4) increased its speed, performance, and maneuverability but required active stability control. A classical Linear Quadratic Regulator (LQR), whose inputs were derived from a rate gyro and accelerometer, was employed to stabilize the inverted pendulum. The LQR optimizes the behavior of the inverted pendulum in the neighborhood of the vertical posture. However, the platform will fall over when the state of the platform departs significantly from the original linearized model. uBot-2 showed a respectable mean time between failures despite many crash landings, usually caused by forces exerted on the

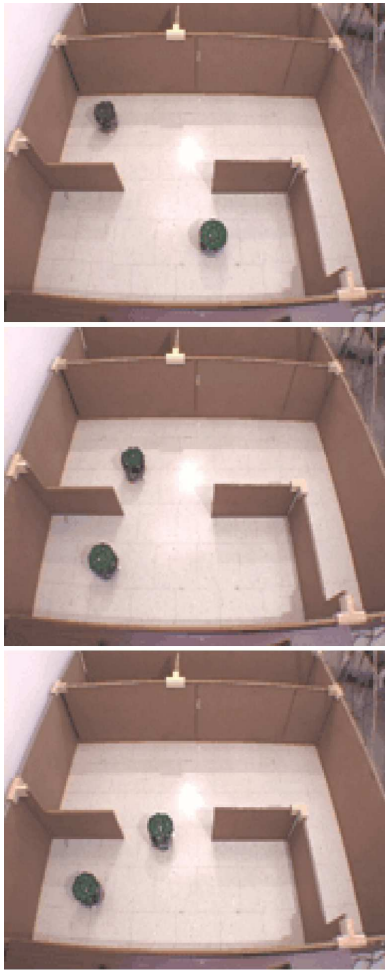

Fig. 3. Two uBot-1 robots performing a maze exploration while maintaining the line-of-sight constraint.

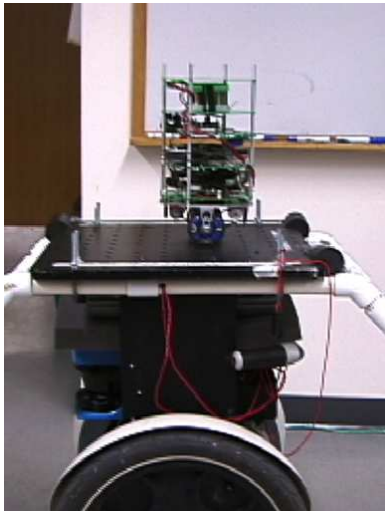

Fig. 4. The uBot-2 balancing on top of a balancing Segway RMP.

robot. This robustness is due in part to the small scale of the platform which results in relatively small impact forces. Another benefit of robustness is that the physical platform can

be used to explore the bounds of the stability controller and it can attempt tasks that could potentially result in a loss of stability.

An additional benefit of balancing on two wheels is that the robot is naturally compliant in the direction of forward and backward motion of the non-holonomic base. This natural compliance can enhance safety when the platform is operating around people since the platform tends to comply easily to environmental forces.

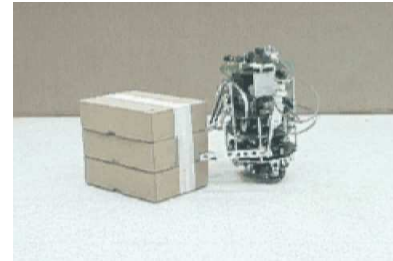

Fig. 5. Balancing uBot-3 pushing a box.

The uBot-3 (Figure 5) started as a feasibility study into mobile manipulation on a dynamic balancer by enhancing uBot-2 with two 3 degree of freedom arms actuated by hobby servos. The uBot-3 was used primarily to conduct simple pushing experiments. To achieve stable pushing, the vertical projection of the center of mass was controlled so that it leveraged weight of the robot more effectively than a statically stable configuration.

In a previous paper the authors explored the advantage of using whole body postural control to apply forces at a manipulator's end effector [1]. The static analysis performed also demonstrated how different design choices affected the robot's ability to resist forces and introduced a simple metric to compare the force generation capabilities of mobile manipulators. To support the analysis, a simple drawer pushing experiment was performed with dynamically and statically stable versions of the uBot-3. A comparable statically stable robot without the capacity for whole body postural control was created by replacing the casters at the front and back of the robot that that were used on uBot-1. Figure 6 shows that the dynamically stable platform was able to successfully push in a drawer using whole body postural control, while the statically stable platform was not able to accomplish the same task.

The feasibility study also concluded that with only 3-DOF per arm, this version of the uBot had a limited bimanual workspace. Because of the low power motors, uBot-3 was also not able not to get back up after it had fallen over.

To address these needs, uBot-4 was redesigned bottom-up. The uBot-4 has two 4 degree of freedom arms with integrated force feedback and passive compliance. Relative to the uBot-3, the uBot-4 has a higher center of mass, larger wheels, a higher top speed, and more battery capacity. The workspace is increased by an additional degree of freedom in the arms and a torso rotation. Figure 7 demonstrates that the workspace includes a large area on the ground plane. This makes it

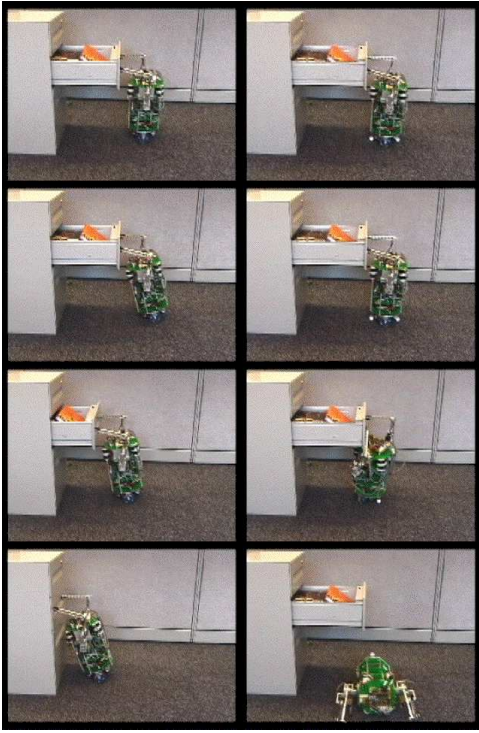

Fig. 6. The dynamically stable platform (uBot-3, left) and statically stable platform (uBot-3 with casters replaced and LQR turned off, right) pushing a drawer filled with books.

possible to perform pick and place tasks with appropriately sized objects.

It was also determined that a requirement of the uBot-4 would be the ability to survive a fall and then right itself. In order to survive a fall, the uBot-4 was designed to be mechanically robust to the magnitude of impact forces expected. At this time, the uBot-4 prototype utilizes motors that do not meet the design specification and therefore is not able to recover from a fall.

TABLE I
UBOT-4 PHYSICAL PARAMETERS

Property	Value
Height	0.542m
Width	0.478m
Depth	0.152m
Footprint Width	0.280m
Footprint Depth	0.152m
Arm Length	0.502m
Weight	11.5kg
Battery Capacity	10.8Ah at 14V
Lifting Capacity of two arms at Full Extension	1.85kg mass
Top speed	4km/h

Another design requirement of the uBot-4 is that it should be capable of accurately sensing contact forces. Expensive commercially available load cells were determined to be unsuitable because they can become permanently damaged by significant impact forces (i.e. when the uBot falls over). Instead, a specially designed motor mount will enable force

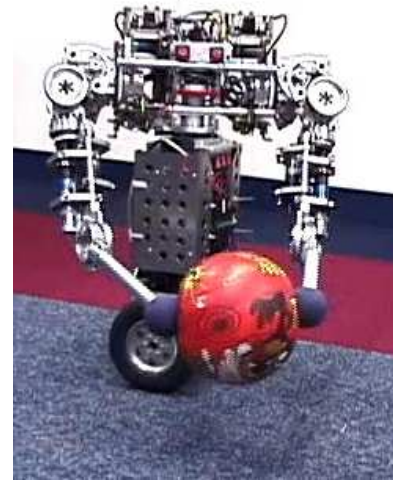

Fig. 7. uBot-4 picking up a ball.

sensing in each of the arm's actuators. The motor mount employs a beam of spring steel that is compliant to the torque of the motor. Moreover, should a force transducer become damaged, uBot-4 is designed to minimize the time and expense of repairs. Although this design does not provide as much passive compliance as a typical series elastic actuator[15][16], the mechanism is designed to withstand high impact forces. Cages around the motors and pulleys provide protection from impacts with surfaces such as the ground. For battery operated devices, such as the uBot-4, this design also allows for gear trains that enable low backdrivability. Since manipulation tasks can often cause a motor to operate at or near stall conditions, low backdrivability helps to conserve power. Experimental verification of the performance and robustness of the force sensing mechanism is still being conducted. Final testing of the force controlled actuators will continue after the completion of a new FPGA based motor control solution.

Like the uBot-3, uBot-4 can control the angle of its body with respect to vertical. This is key to improving the capacity of a mobile manipulator to exert force on the environment. Figures 9 and 10 show the predicted force advantage of

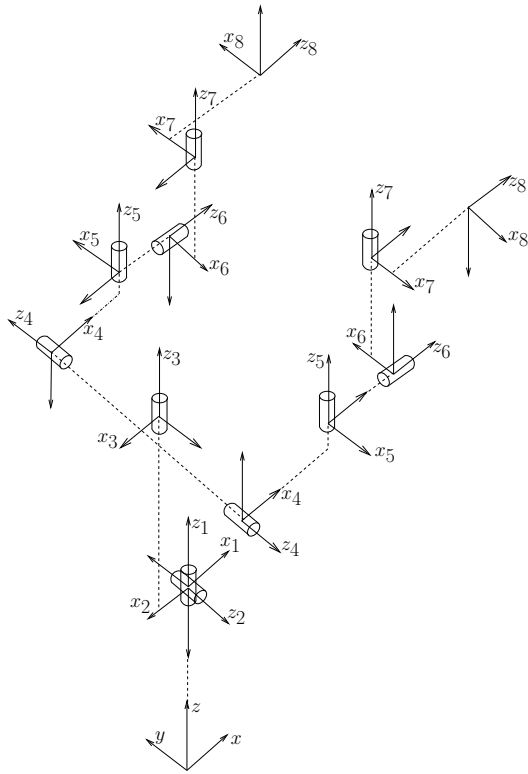

Fig. 8. uBot-4 kinematics: The frame convention follows Craig and the Modified D-H standard[14].

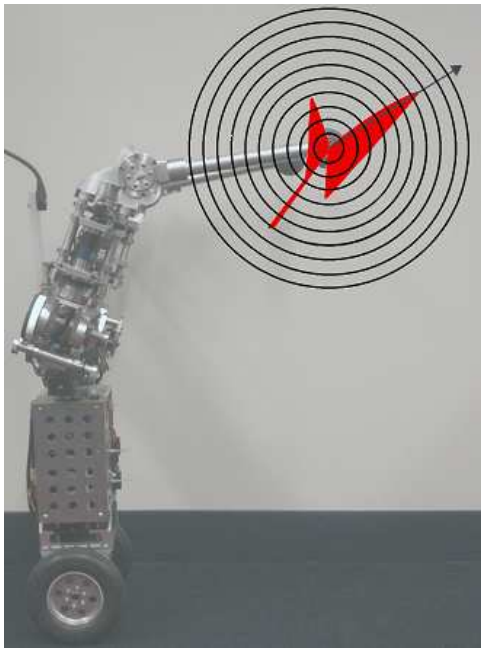

Fig. 9. Increase in forces that can be applied to the environment using whole body postural control, for an end effector height of 0.75m. Each concentric circle corresponds to a 2N increment, i.e. the platform using whole body postural control can apply roughly 15N more in the direction indicated by the arrow than the platform with limited postural control.

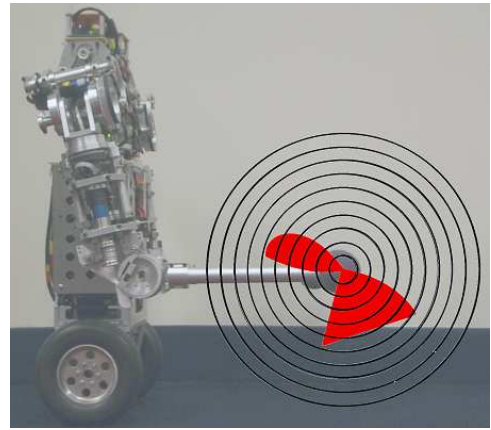

Fig. 10. Increase in forces that can be applied to the environment using whole body postural control, for an end effector height of 0.19m. Each concentric circle corresponds to a 2N increment.

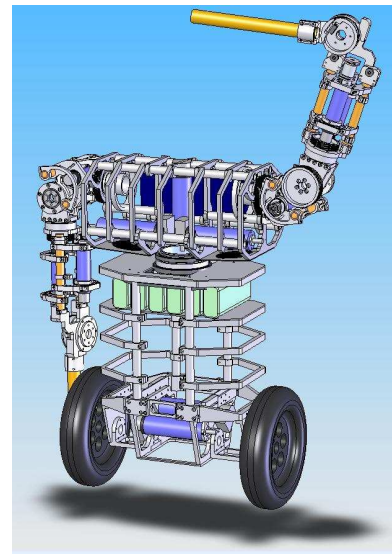

Fig. 11. Concept rendering of uBot-5, currently under design.

using whole body postural control to generate force at the end effectors of the uBot-4 for two different postures of the robot[1]. For some configurations of the uBot-4, this advantage is as great as 35N in some directions. When in contact with the environment, whole body postural control provides useful advantages over robots with statically stable bases.

uBot-5 (Figure 11) is also currently under design, employing mass reduction and significant analysis of motor requirements. The new design will also feature larger wheels, increased internal volume, and a higher center of mass.

IV. CONCLUSION

The uBot-4 a highly mobile manipulation platform with a small footprint and the capacity to address tasks that require expert control of contact forces and momentum. As stated earlier, a major motivation for the design of the uBot-4 was to fill a current need in the robotics community by creating a simple, robust, cost effective, and safe mobile manipulation

platform. While not all of the properties of the uBot-4 design have been experimentally verified (the prototype is missing force sensing actuators, high performance motor controllers, and sufficiently powerful motors), so far the design appears to be successful. The size, weight, passive compliance due to balancing, and potential active compliance enabled by the force sensing actuators of the uBot-4 contributed to the safety of the platform. The static analysis of contact forces and pushing experiments summarized verify that the morphology of the uBot-4 helps maximize the platforms power-to-weight ratio. By using compliant force sensing actuators at every joint in each arm, we hope to maximize the manipulation capacity of the platform. While experimental verification of the final power, speed, and dexterity must wait until a fully featured platform is built, the performance of the prototype suggests that the uBot-5 will perform very well.

ACKNOWLEDGMENT

The authors would like to thank Ed Hannigan and Dirk Ruiken for their contribution to the implementation of the uBot-4. This work was supported by NASA grant NNJ05HB61A-5710001842 and ARO grant W911NF-05-1-0396.

REFERENCES

- [1] B. J. Thibodeau, P. Deegan, and R. Grupen, "Static Analysis of Contact Forces With a Mobile Manipulator," in *Proceedings of the 2006 IEEE International Conference on Robotics and Automation*, Orlando, FL, May 2006.
- [2] R. Grupen and O. Brock, "Integrating Manual Dexterity with Mobility for Human-Scale Service Robotics," <http://www-robotics.cs.umass.edu/~gruppen/whitepaper-mobmanip.pdf>, 2004.
- [3] Y. Sakagami, R. Watanabe, C. Aoyama, S. Matsunaga, N. Higaki, and K. Fujimura, "The Intelligent ASIMO: System Overview and Integration," in *Proceedings of the 2002 IEEE/RSJ Intl. Conference on Intelligent Robots and Systems*, Lausanne, Switzerland, October 2002, pp. 2478–2483.
- [4] K. Kaneko, F. Kanehiro, S. Kajita, H. Hirukawa, T. Kawasaki, M. Hirata, K. Akachi, and T. Isozumi, "Humanoid Robot HRP-2," in *Proceedings of the 2004 IEEE International Conference on Robotics and Automation*, New Orleans, LA, April 2004, pp. 1083–1090.
- [5] H. G. Nguyen, J. Morrell, K. Mullens, A. Burmeister, S. Miles, N. Farrington, K. Thomas, and D. W. Gage, "Segway Robotic Mobility Platform," in *SPIE Proc. 5609: Mobile Robots XVII*, Philadelphia, PA, October 2004.
- [6] (2005, November). [Online]. Available: <http://www.geology.smu.edu/dpa-www/robo/nbot/>
- [7] F. Grasser, A. D'Arrigo, S. Colombi, and A. C. Rufer, "JOE: A Mobile, Inverted Pendulum," *IEEE Transactions on Industrial Electronics*, vol. 49, no. 1, pp. 107–114, February 2002.
- [8] T. B. Lauwers, G. A. Kantor, and R. L. Hollis, "A Dynamically Stable Single Wheeled Mobile Robot with Inverse Mouse-Ball Drive," in *Proceedings of the 2006 IEEE International Conference on Robotics and Automation*, Orlando, FL, May 2006.
- [9] R. Brooks, L. Aryananda, A. Edsinger, P. Fitzpatrick, C. Kemp, U.-M. O'Reilly, E. Torres-Jara, P. Varshavskaya, and J. Webber, "Sensing and Manipulating Build-For-Human Environments," *International Journal of Humanoid Robotics*, vol. 1, no. 1, pp. 1–28, March 2004.
- [10] R. O. Ambrose, R. T. Savely, S. M. Goza, P. Strawser, M. A. Diftler, I. Spain, and N. Radford, "Mobile Manipulation using NASA's Robonaut," in *Proceedings of the 2004 IEEE International Conference on Robotics and Automation*, New Orleans, LA, April 2004, pp. 2104–2109.
- [11] (2006, August). [Online]. Available: <http://www.segway.com/products/rmp/models.html>
- [12] V. Braitenberg, *Vehicles: Experiments in Synthetic Psychology*. MIT Press, 1984.
- [13] J. Sweeney, T. Brunette, Y. Yang, and R. Grupen, "Coordinated Teams of Reactive Mobile Platforms," in *Proceedings of the IEEE Conference on Robotics and Automation*, Washington, D.C., May 2002.
- [14] J. J. Craig, *Introduction to Robotics: Mechanics and Control*. Boston, MA, USA: Addison-Wesley Longman Publishing Co., Inc., 1989.
- [15] G. A. Pratt and M. M. Williamson, "Series Elastic Actuators," in *Proceedings of the IEEE/RSJ International Conference on Intelligent Robots and Systems*, vol. 1, Pittsburg, PA, July 1995, pp. 399–406.
- [16] A. Edsinger-Gonzales and J. Weber, "Domo: A Force Sensing Humanoid Robot for Manipulation Research," *International Journal of Humanoid Robotics*, vol. 1, pp. 273–291, 2004.